

MOLTO LUCE

GATOR & FOAM





MOLTO LUCE



- Decorative LED luminaire in two sizes
- Opal diffuser, decorative mirror or matte white center plated
- Wall or ceiling mounting
- 0-10 dimming standard

- Luminaria LED decorativa en dos dimensiones
- Con difusor opal, con espejo decorativo o un plato central blanco mate
- Montado en la pared o el techo
- Atenuación 0-10

- Luminaire décoratif LED en deux tailles
- Diffuseur Opal, miroir décoratif ou centre blanc mat plaqué
- Le montage mural ou au plafond
- 0-10 norme gradation

GATOR S

SYS 22W • 120-277V AC • CRI >80 • Binning SDCM 3

614-110195usa		white	3000K • 1850 lm
614-110145usa		white	4000K • 2000 lm
614-110190usa		mirror	3000K • 1850 lm
614-110140usa		mirror	4000K • 2000 lm

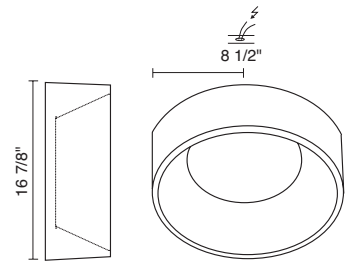

GATOR M

SYS 34W • 120-277V AC • CRI >80 • Binning SDCM 3

614-120195usa		white	3000K • 2800 lm
614-120145usa		white	4000K • 3000 lm
614-120190usa		mirror	3000K • 2800 lm
614-120140usa		mirror	4000K • 3000 lm

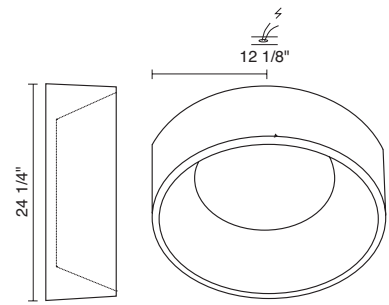

= LED 3000K
 = LED 4000K

IP20

LED PERFORMANCE

Manufacturer: Osram
Part Number: GW SBLMA.CM
CCT Options: 2700K/3000K/3500K/4000K
Chromaticity Range: 3 step MacAdam (SDCM3)
CRI Options: >90
Typical CRI: 92







- Organic shaped three-piece surface luminaire
- Opal diffuser with chrome driver housing
- Wall or ceiling mounting
- Combine multiple units for unique designs
- 0-10 dimming standard

- Luminaria de superficie de tres piezas en forma de espuma
- Con difusor opal con una cubierta de cromo
- Montado en la pared o el techo
- Se pueden combinar múltiples unidades para crear diseños únicos.
- Atenuación 0-10



- Organique en forme de trois pièces surface luminaire
- Diffuseur opale avec chauffeur chrome logement
- Le montage mural ou au plafond
- Combiner plusieurs unités pour des conceptions uniques
- 0-10 norme gradation

FOAM

SYS 37W • 100-240V AC • CRI >80 • Binning SDCM 3

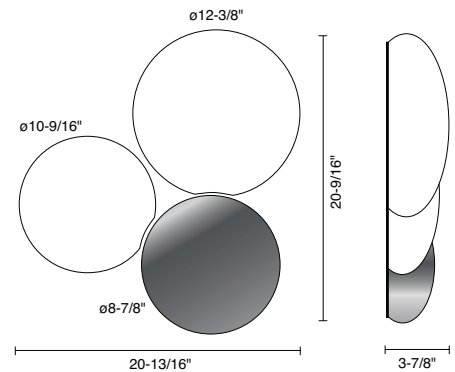
598-110191usa  chrome 3000K • 2130 lm
 598-110141usa  chrome 4000K • 2340 lm



 = LED 3000K
 = LED 4000K

IP20    

LED PERFORMANCE

Manufacturer: Osram
Part Number: GW CSSRM1.BM
CCT Options: 2700K/3000K/3500K/4000K
Chromaticity Range: 3 step MacAdam (SDCM3)
CRI Options: >90
Typical CRI: 95



MOLTO LUCE

15774 GATEWAY CIRCLE

TUSTIN, CA 92780

P 714.259.9959

F 714.259.9969

INFO@MOLTOLUCELIGHTING.COM

LEDRAbrands

MOLTOLUCELIGHTING.COM