

MOLTO LUCE

LASH







- Organic shaped LED surface mounted luminaire
- High efficiency opal diffuser of rotomoulded polyethylene
- Chrome end caps
- Dimmable 0-10V
- Highly Efficient LED

- LED luminaria de superficie en forma orgánica
- Alta eficiencia opal difusor en polietileno rotomoldeado
- Oscuras tapas cromadas
- Regulables 0 -10 voltios
- LED de alta eficiencia

- Luminaria de superficie LED en forma orgánica
- Difusor opal de polietileno moldeado en rotacional
- Tapas de los extremos de alta calidad en cromado oscuro
- Regulable 1-10V
- Eficiente de la energía con un alto rendimiento de color del LED

W3 = LED 3000K  
W4 = LED 4000K



IP20    

#### LED PERFORMANCE

LED: Osram  
DUV: +/- .005  
CCT: 3000K, 4000K  
CRI: >80  
Warranty: 5 year limited warranty

## LASH WALL / CEILING

SYS 50W • 120-272V AC • CRI >80 • Binning SDCM 3

660-30195usa  opal diffuser 3000K • 5100 lm  
660-30145usa  opal diffuser 4000K • 5650 lm

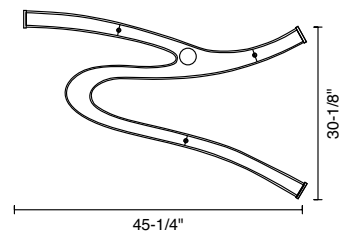
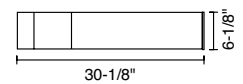
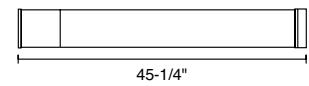

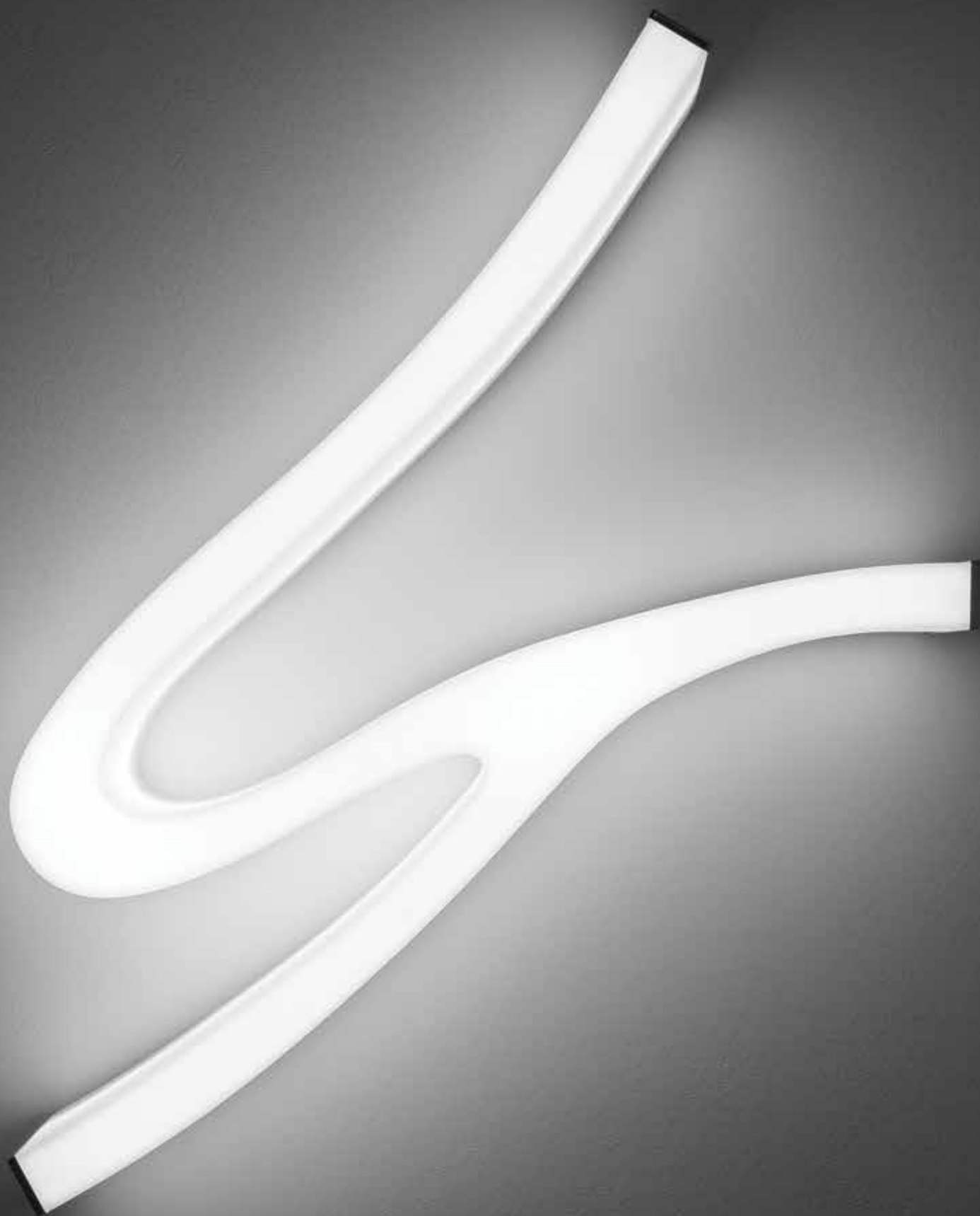



- Organic shaped LED pendant suspension luminaire
- High efficiency opal diffuser of rotomoulded polyethylene
- Chrome end caps
- Dimmable 0-10V
- Highly Efficient LED

- LED luminaria de superficie en forma orgánica
- Alta eficiencia opal difusor en polietileno rotomoldeado
- Oscuras tapas cromadas
- Regulables 0 -10 voltios
- LED de alta eficiencia

- Suspension LED, forme organique
- Diffuseur opal en polyéthylène
- Embout en haute qualité
- Dimmable 1-10V
- Câble de suspension 3m inclus, réglable sans outil

W3 = LED 3000K  
W4 = LED 4000K



IP20    

**LED PERFORMANCE**

LED: Osram  
 DUV: +/- .005  
 CCT: 3000K, 4000K  
 CRI: >80  
 Warranty: 5 year limited warranty

**LASH PENDANT**

SYS 50W • 120-277V AC • CRI >80 • Binning SDCM 3

660-10195usa  opal diffuser 3000K • 5100 lm  
 660-10145usa  opal diffuser 4000K • 5650 lm

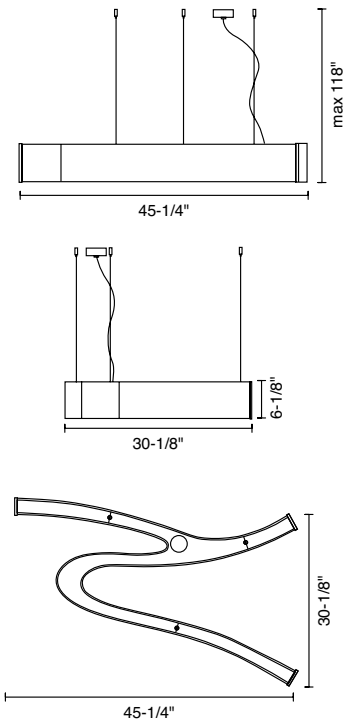





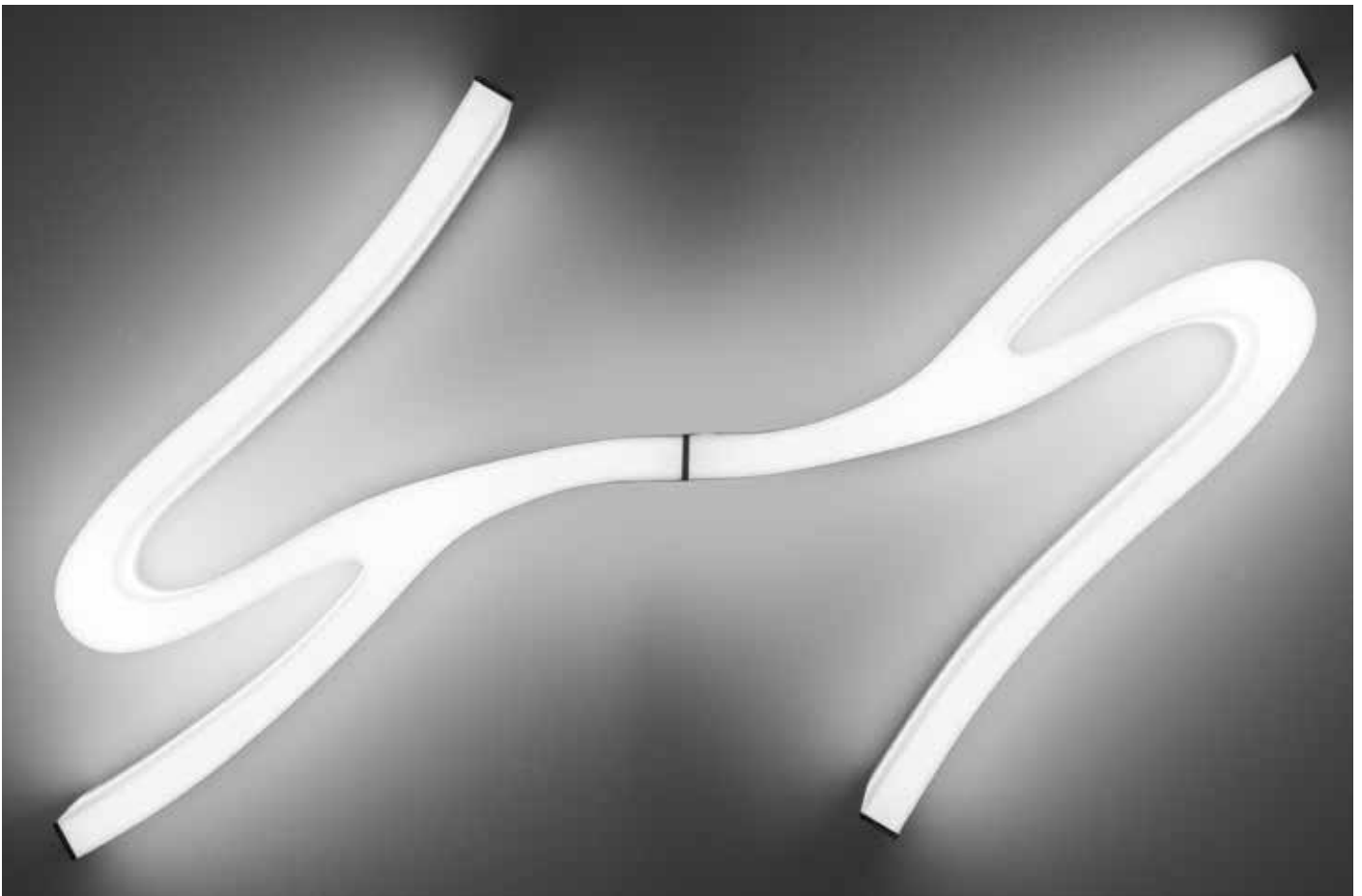

- Organic shaped LED pendant or surface system luminaire
- High efficiency opal diffuser of rotomoulded polyethylene
- Chrome end caps and connectors
- Connect up to 15 on one feed
- Dimmable 0-10V
- Highly Efficient LED

- LED colgante o sistema de luminaria syrface en forma orgánica
- Alta eficiencia opal difusor en polietileno rotomoldeado
- Oscuras tapas cromadas
- Conectar hasta 15 en un alimento
- Regulares 0 -10 voltios
- LED de alta eficiencia

- Luminaria de superficie LED en forma orgánica
- Difusor opal de polietileno moldeado en rotacional
- Tapas de los extremos de alta calidad en cromado oscuro
- Regulable 1-10V
- Energía eficiente con un alto rendimiento de color del LED

W3 = LED 3000K

W4 = LED 4000K

IP20    

#### LED PERFORMANCE

LED: Osram  
 DUV: +/- .005  
 CCT: 3000K, 4000K  
 CRI: >80

Warranty: 5 year limited warranty

## LASH SYSTEM WALL / CEILING

SYS 50W • 120-277V AC • CRI >80 • Binning SDCM 3

660-40195usa  opal diffuser 3000K • 5100 lm

660-40145usa  opal diffuser 4000K • 5650 lm

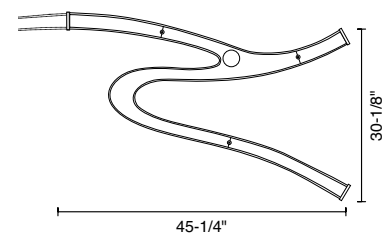
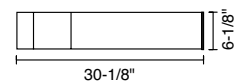
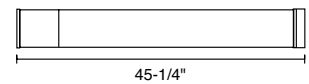

## END PIECE

660-21usa end piece

## SYSTEM JUNCTION

660-42dusa dimmable

## POWER CANOPY

max. 10 luminaires per power feed

660-401dusa 5 x 1,5mm<sup>2</sup>







- Organic shaped LED pendant or surface system luminaire
- High efficiency opal diffuser of rotomoulded polyethylene
- Chrome end caps and connectors
- Connect up to 15 on one feed
- Dimmable 0-10V
- Highly Efficient LED

- LED colgante o sistema de luminaria syrface en forma orgánica
- Alta eficiencia opal difusor en polietileno rotomoldeado
- Oscuras tapas cromadas
- Conectar hasta 15 en un alimento
- Regulables 0 -10 voltios
- LED de alta eficiencia

- Luminaria de superficie LED en forma orgánica
- Difusor opal de polietileno moldeado en rotacional
- Tapas de los extremos de alta calidad en cromado oscuro
- Regulable 1-10V
- Energía eficiente con un alto rendimiento de color del LED

W3 = LED 3000K  
W4 = LED 4000K



IP20    

#### LED PERFORMANCE

LED: Osram  
DUV: +/- .005  
CCT: 3000K, 4000K  
CRI: >80  
Warranty: 5 year limited warranty

## LASH SYSTEM PENDANT

SYS 50W • 120-277V AC • CRI >80 • Binning SDCM 3  
Included 10 ft. suspension cable, adjustable without tools

660-20195usa  opal diffuser 3000K • 5100 lm  
660-20145usa  opal diffuser 4000K • 5650 lm

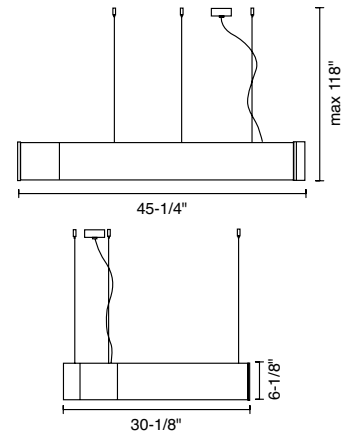
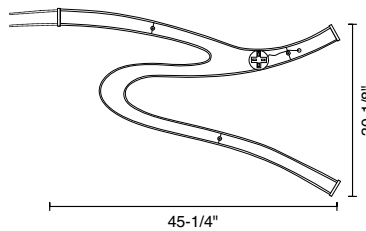

## END PIECE

660-21usa end piece

## SYSTEM JUNCTION

660-22dusa dimmable

## CANOPY SYSTEM

max. 10 luminaires per power feed

581-075usa 3 x 1,5mm<sup>2</sup>  
581-085usa 5 x 1,5mm<sup>2</sup>



MOLTO LUCE

15774 GATEWAY CIRCLE

TUSTIN, CA 92780

P 714.259.9959

F 714.259.9969

[INFO@MOLTOLUCELIGHTING.COM](mailto:INFO@MOLTOLUCELIGHTING.COM)

**LEDRA**brands

**MOLTOLUCELIGHTING.COM**